

T-SERIES QUARTZ TUBE RADIANT HEATERS

MODELS : T-SERIES

The T-series line of medium wave infrared quartz tube heaters direct over 95% of their infrared radiant energy over your process. Through a patented process, an internal reflector/insulator is installed behind the resistance coil.

FEATURES:

1. Permanent Internal reflector
2. Quartz tube
3. Precision resistance coil
4. Welded stainless terminals (see back)
- 5 Ceramic mounting terminal block (not Included)

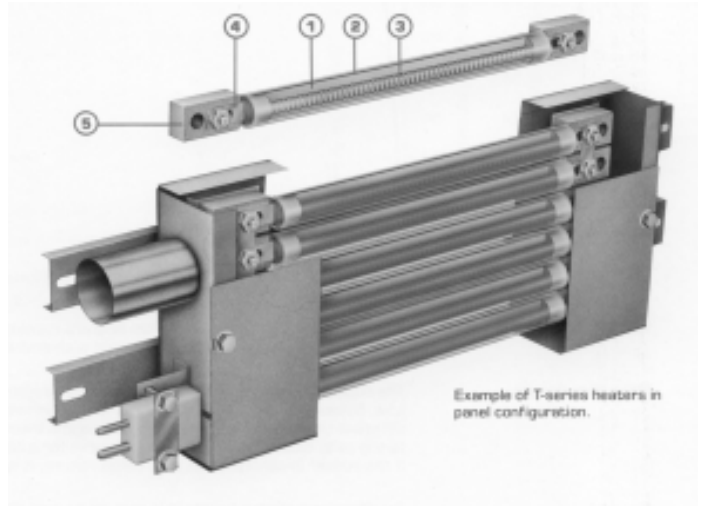

QUALITY CONSTRUCTION

The T-series quartz tube heaters use a 5/8" diameter quartz tube. A ceramic fiber refractory material is machined into 1/2 of the inside diameter of the heated length of the tube. As the heating source we use a precision wound resistance wire made of iron/chromium/aluminum, The resistance coil rests on the refractory material, filling in the other half of the inside diameter of the tube. All terminations are stainless and spot welded. Wire leads and stainless tab terminals are available. Tubes can also be made with both terminations at one end.

QUARTZ ADVANTAGE

Fast Response - There are a number of options to choose from when trying to decide what type of infrared heater to use for your specific process needs. If fast response time is required, quartz tubes are ideal. Peak radiant output can be achieved in less than 15 seconds. With the aid of a purge blower complete cool down can be reached in seconds.

EXTERNAL REFLECTORS NOT REQUIRED

Conventional tubes require an external reflector. which, over time becomes dirty and inefficient. The expense and maintenance of replacing external reflectors is eliminated.

DESIGN FLEXIBILITY

Design requirements for the T-series heaters vary between applications, therefore all tube orders are made to order, Tube length, heated length, watt-age, voltage, and terminations can be custom engineered to fit your specific process needs.

MEDIUM WAVE - OUTPUT

The majority of the infrared energy produced by the T-series line of quartz tube heaters is medium wave. Not to be confused with quartz lamps (T3 & T4) which are in a vacuum and produce mainly short wave IR energy.

QUARTZ TUBE RADIANT HEATERS

STANDARD

SIZES - 6mm, 8mm, 3/8", 1/2", 5/8", 1" DIAMETER
 TRANSLUCENT QUARTZ
 SCREW TERMINAL
 4-6sec HEATUP TIME
 SHORT-MEDIUM WAVELENGTH(2.5-4 micron)
 OPERATING TEMP UP TO 1600F
 LENGTHS - 4" to 96"

OPTIONS

CLEAR QUARTZ (HIGHER EFFICIENCY)
 RUBY QUARTZ (MINIMIZES VISIBLE LIGHT)
 DIFFERENT TERMINALS (SEE BELOW)
 INTERNAL REFLECTOR FOR DIRECTIONAL HEAT
 (CERAMIC FIBER or GOLD)

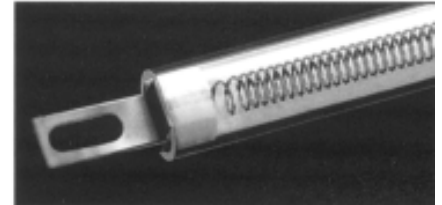
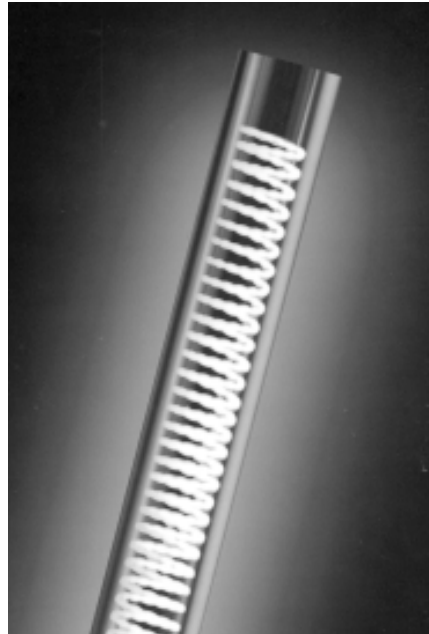

Ceramic reflector insert

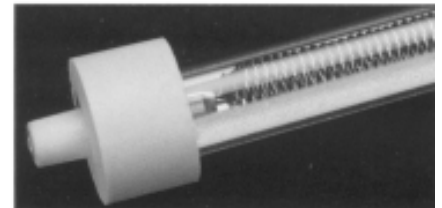

Gold plated tubes provide approximately 93% reflectivity

CERAMIC HOLDER

FLAT OVERCAP



TIPPED OVERCAP

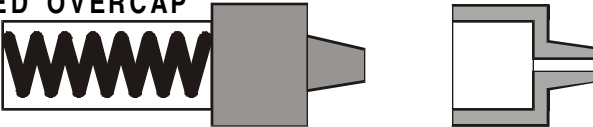

INSERT CERAMIC

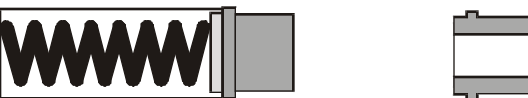

STEPPED CAP

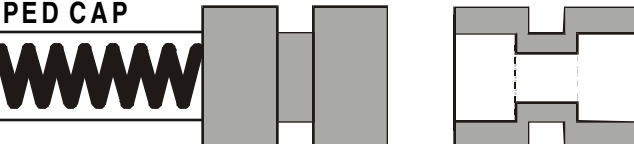

TERMINATION

STUD TERMINAL

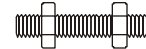

FORK TERMINAL



RING TERMINAL



SPADE TERMINAL



HIGH TEMP WIRE LEADS

